

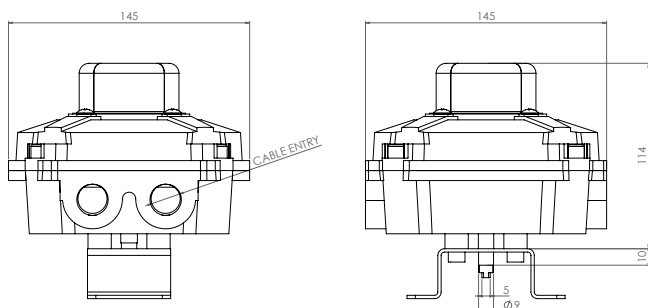

KS2L ATEX IN ALLUMINIO CON INDICATORE VISIVO

KS2L ATEX ALUMINIUM WITH OPTICAL INDICATOR

 II2GD Exd IIC T6

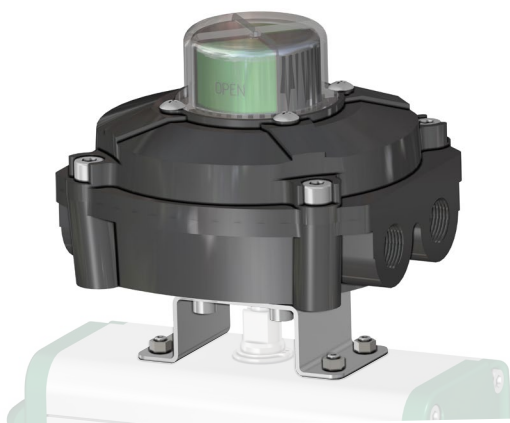

CODICE DI ORDINAZIONE

ENCODING

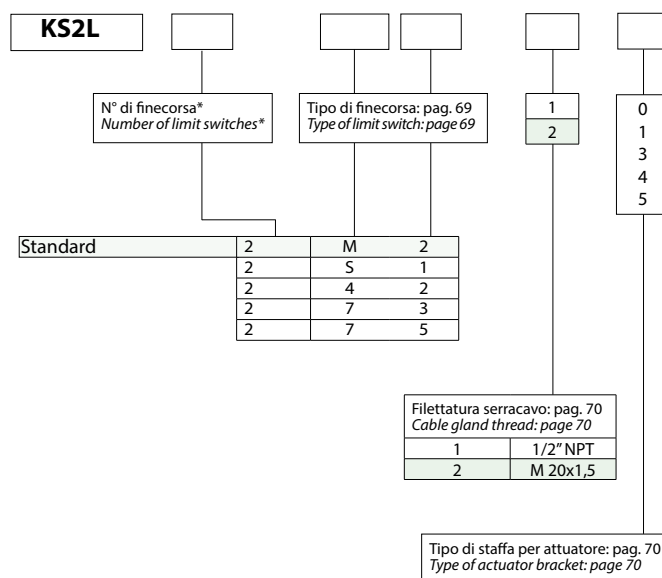

*A richiesta disponibili da 1 a 4 finecorsa
*From 1 to 4 limit switches available on request

CARATTERISTICHE PRINCIPALI

- Realizzato per verificare facilmente la posizione visiva ed elettrica di ogni valvola anche da lunghe distanze.
- Costruito a norme VDI/VDE 3845 standard. (EN15714-3)
- Può contenere al suo interno due finecorsa di segnalazione sia di tipo meccanico "SPDT" che di prossimità.
- Precisa regolazione delle camme tramite sistema "millerighe".
- Morsettiera a 10 postazioni.
- N° 2 connessioni elettriche filettate per serracavo.
- Temperatura di esercizio STD: da -20°C a +60°C (NBR)
- Grado di Protezione: IP 66/67.

MATERIALI

- Corpo e coperchio: alluminio pressofuso a basso contenuto di rame rivestito con doppio strato di verniciatura epossidica nera*.
- Indicatore: policarbonato e ABS.
- Albero: acciaio inossidabile.
- Viti: acciaio inossidabile.

* A richiesta anche in acciaio inox CF8M.

CERTIFICAZIONI

- Dichiarazione di conformità CE a richiesta
- ATEX, IEC Ex  II2GD Exd IIC T6
- Fino a SIL 2

TECHNICAL FEATURES

- Made to easily verify the visual and electrical position of each valve even from long distances.
- Built according to VDI / VDE 3845 standards. (EN15714-3)
- It can contain two limit switches either mechanical "SPDT" or proximity.
- Precise cam adjustment via "Miller" system.
- 10 positions terminal block.
- N. 2 threaded electrical connections for cable gland.
- Operating temperature: from -20°C to +60°C (NBR).
- Protection rate: IP 66/67.

MATERIALS

- Body and cover: Low-Copper Aluminum Die Coated with Double Epoxy Coating*.
 - Indicator: polycarbonate and ABS
 - Shaft: Stainless steel
 - Screws: Stainless steel
- * On request also in stainless steel CF8M

CERTIFICATIONS

- CE declaration of conformity on request
- ATEX, IEC Ex  II2GD Exd IIC T6
- Up to SIL 2



TIPI DI FINECORSA CONTENUTI NEI BOX KS2L

TYPES OF LIMIT SWITCHES CONTAINED IN BOX KS2L

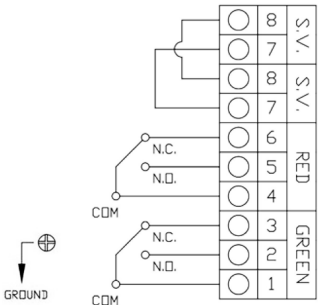
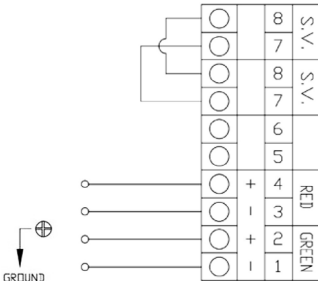
CODE*	DESCRIZIONE DESCRIPTION	VERSIONE VERSION	COLLEGAMENTO ELETTRICO WIRING DIAGRAM
M2	Microinterruttori elettromeccanici SPDT con contatti argentati (OMRON D3V o CHERRY D44) <i>SPDT Electromechanical microswitches with silver plated contacts (OMRON D3V o CHERRY D44)</i> Max: 250 Vac 11A -250 Vdc 0.3A - 30 Vdc 3A	Di serie Standard	
S1	Micronteruttori di prossimità magnetici SPDT HSR 834 W <i>Micronteruttori di prossimità magnetici SPDT HSR 834 W</i> Max: 240 Vac 0.416A -240 Vdc 0.416A - 33 Vdc 3A	A richiesta On request	
42	Microinterruttori elettromeccanici SPDT con contatti dorati (HONEYWELL V7) <i>SPDT Electromechanical microswitches SPDT with gold plated contacts (HONEYWELL V7)</i> Max: 250 Vac 11A	A richiesta On request	
73	Microinterruttori di prossimità amplificati 3 fili PNP NO P+F NBB2 V3 E2, <i>3-wire amplified proximity microswitches PNP NO P+F NBB2 V3 E2,</i> 10÷30 VDC; 100 mA - operating current 0 - 100 mA	A richiesta On request	
75	Microinterruttori di prossimità amplificati IFM IS 5026, 2 fili <i>2-wire amplified proximity microswitches IFM IS 5026</i> 5÷36 Vdc; 4÷200 mA	A richiesta On request	

NOTA: Per versione DPDT disponibile a richiesta 4 x SPDT (solo per elettromeccanici)
NOTE: DPDT version available on request 4 x SPDT (electromechanical only)

* La sigla che identifica il tipo di finecorsa usati, compare nel codice del box al 6° e 7° posto.

* The symbol that identifies the type of limit switches used, appears in the code box in the 6th and 7th position.



STAFFA DI CONNESSIONE TRA ATTUATORE E BOX FINECORSA CONNECTION BRACKET BETWEEN ACTUATOR AND LIMIT SWITCHES BOX

KS3L - KS2L

TIPO DI STAFFA* TYPE OF BRACKET*	DESCRIZIONE DESCRIPTION
0	Connessione NAMUR 25x50x20* (*20=altezza albero attuatore, quota A in figura) Namur connection 25x50x20* (*20=height of the actuator shaft, dimension A as per picture)
1	Connessione NAMUR 30x80x20* (*20 = altezza albero attuatore, quota A in figura) Namur connection 30x80x20* (*20=height of the actuator shaft, dimension A as per picture)
3	Connessione NAMUR 30x80x30* (*30 = altezza albero attuatore, quota A in figura) Namur connection 30x80x30* (*30=height of the actuator shaft, dimension A as per picture)
4	Connessione NAMUR 30x80x30* (*30= altezza albero attuatore, quota A in figura) Namur connection 30x80x30* (*30=height of the actuator shaft, dimension A as per picture)
5	Connessione NAMUR 30x130x30* (*30= altezza albero attuatore, quota A in figura) Namur connection 30x130x30* (*30=height of the actuator shaft, dimension A as per picture)

*La staffa compare nell'ultimo carattere del codice del box per finecorsa. Per ordinare solo la staffa ricorrere al codice Actuatech.

*The bracket appears in the last position of the limit switches box code. If you need to order only the bracket, please refer to the Actuatech code.

PER ATTUATORI IN ALLUMINIO FOR ALUMINIUM ACTUATORS

MISURA SIZE	GD15÷GD120 GS15÷GS60	GD180÷GD960 GS90÷GS480	GD1440÷GD1920 GS720÷GS960	GD2880÷GD8000 GS1440÷GS4000
Codice Code	KCPL1015	KCPL1060	KCPL2060	KCPL1A04
Tipo di staffa Type of bracket	1	3	4	5
A (mm)	20	30	30	30
B (mm)	30	40	40	40
C (mm)	30	30	30	30
D (mm)	80	80	80	130

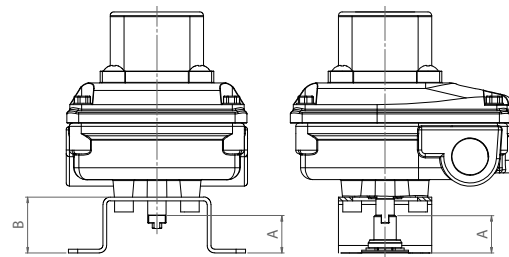

PER ATTUATORI IN ACCIAIO INOX FOR STAINLESS STEEL ACTUATORS

MISURA SIZE	GD15**÷GD30** GS15**	GD60 GS30	GD120÷GD960 GS60÷GS480	GD1440÷GD1920 GS720÷GS960
Codice Code	KCPL0015		KCPL1060	KCPL2060
Tipo di staffa Type of bracket	0	0	3	4
A (mm)	20	20	30	30
B (mm)	30	30	40	40
C (mm)	25	25	30	30
D (mm)	50	50	80	80

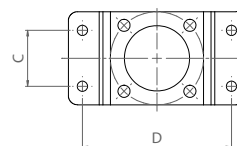

** Previo utilizzo interfaccia per attuatore KBVI4015

** Use connection bracket for actuator: KBVI4015

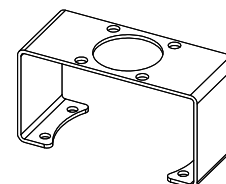

Per "Tipo di staffa" codice 4
For "Type of bracket" code 4

FILETTATURE DEL SERRACAPO DEL BOX BOX CABLE ENTRIES THREAD

Tipo di filettatura del serracavo*** Type of cable gland thread***	Descrizione Description	Note Notes
1	1/2" NPT	A RICHIESTA ON REQUEST
2	M 20x1,5	STANDARD

*** Il tipo di filettatura è indicato nell'ottavo carattere del codice del box. *** Thread is indicated in 8th digit in the code of the box.

SERRACAVI: Non inclusi. CABLE GLANDS: Not included.